



**RCA MANUFACTURING COMPANY, INC.**

A RADIO CORPORATION OF AMERICA, SUBSIDIARY

*Harrison, New Jersey*

**RCA RADIOTRON  
D I V I S I O N**

APPLICATION NOTE No. 77

July 14, 1937

APPLICATION NOTE  
ON  
DIMENSIONS OF POPULAR TUBE TYPES

A large number of tube types are available for use in radio receivers. However, all tube types are not used to the same extent. A recent analysis of tube complements used in modern receivers shows that certain tube types are more popular than others. The popularity of these types is due to their economic and technical advantages in a wide variety of receiver models.

A list of popular tube types based on experience with manufacturers is presented in this Note. This list, which satisfies most requirements of equipment manufacturers, is presented as an aid in reducing the number of tube types from which selections are made. It is suggested that these types be given special consideration when designing new equipment.

Chart I classifies the popular tube types according to their function and cathode voltages. This chart is intended to assist the user in choosing a tube type for an application. Chart II classifies all-metal tubes in numerical order. Chart III classifies glass-type tubes in numerical order.

Overall dimensions (outlines), base dimensions, and socket connections are given for each tube type in order to facilitate mechanical design. The final column in Chart II and Chart III lists similar types. A similar type may not be a popular type; the column is provided merely to aid the user in identifying a comparatively new type number.

Copyright, 1937 by  
RCA Manufacturing Co., Inc.

AN-77-6-30-37  
Printed in U.S.A.

*RCA Cunningham • Radiotron Radio Tubes • RCA Radiotron Transmitting Tubes • Special Purpose Tubes • Photo Tubes • Cathode Ray Tubes  
Genuine RCA Replacement Parts, Accessories and Test Equipment*

## CHART I

Cathode Volts	2.0	5.0		6.3		25.0	
Type Classification	Glass	All-Metal	Glass	All-Metal	Glass	All-Metal	Glass
<b>DIODES</b>							
Detector - <i>Twin</i>				6H6			
Rectifier - <i>Full-wave</i>		5T4 5W4	5U4-G 5Y3-G	6X5	6X5-G		
Rectifier-Doubler						25Z6	25Z6-G
<b>TRIODES</b>							
Voltage Amplifier-							
<i>Medium Mu</i>	1H4-G			6C5 6J5	6J5-G		
<i>Medium Mu with Diodes</i>				6R7	6R7-G		
<i>High Mu</i>				6F5			
<i>High Mu with Diodes</i>				6Q7	6Q7-G		
Class B Amplifier - <i>Twin</i>	1J6-G			6N7	6N7-G		
<b>BEAM POWER TUBES</b>							
				6L6	6L6-G	25L6	25L6-G
<b>PENTODES</b>							
Voltage Amplifier-							
<i>Sharp Cut-off</i>	1E5-G			6J7	6J7-G		
<i>Remote Cut-off</i>	1D5-G			6K7	6K7-G		
<i>Remote Cut-off with Diodes</i>	1F7-G						
Power Amplifier	1F5-G			6F6	6F6-G 6K6-G	25A6	25A6-G
<b>PENTAGRID CONVERTERS</b>							
	1C7-G			6A8	6A8-G		
<b>PENTAGRID MIXERS</b>							
				6L7	6L7-G		
<b>ELECTRON-RAY TUBES</b>							
					6E5 6G5		

## CHART II ALL-METAL TUBES

TUBE TYPE	OVERALL DIMENSIONS	BASE	SOCKET CONNECTIONS	SIMILAR TYPE
5T4	FIG. 6	Large Wafer Octal 5-Pin	5T	5U4-G 5Z3
5W4	FIG. 3	Small Wafer Octal 5-Pin	5T	5Y3-G 80
6A8	FIG. 2	Small Wafer Octal 8-Pin	8A	6A7 6A8-G
6C5	FIG. 4	Small Wafer Octal 6-Pin	6Q	6C5-G
6F5	FIG. 2	Small Wafer Octal 5-Pin	5M	6F5-G
6F6	FIG. 3	Small Wafer Octal 7-Pin	7S	6F6-G 42
6H6	FIG. 1	Small Wafer Octal 7-Pin	7Q	6H6-G
6J5	FIG. 5	Small Wafer Octal 6-Pin	6Q	6J5-G
6J7	FIG. 2	Small Wafer Octal 7-Pin	7R	6C6 6J7-G
6K7	FIG. 2	Small Wafer Octal 7-Pin	7R	6D6 6K7-G
6L6	FIG. 7	Small Wafer Octal 7-Pin	7AC	6L6-G
6L7	FIG. 2	Small Wafer Octal 7-Pin	7T	6L7-G
6N7	FIG. 3	Small Wafer Octal 8-Pin	8B	6A6 6N7-G
6Q7	FIG. 2	Small Wafer Octal 7-Pin	7V	6Q7-G
6R7	FIG. 2	Small Wafer Octal 7-Pin	7V	6R7-G
6X5	FIG. 3	Small Wafer Octal 6-Pin	6S	6X5-G 84
25A6	FIG. 3	Small Wafer Octal 7-Pin	7S	25A6-G 43
25L6	FIG. 3	Small Wafer Octal 7-Pin	7AC	25L6-G
25Z6	FIG. 3	Small Wafer Octal 7-Pin	7Q	25Z5 25Z6-G

## CHART III GLASS TUBES

TUBE TYPE	OVERALL DIMENSIONS	BASE	SOCKET CONNECTIONS	SIMILAR TYPE
1C7-G	FIG. 10	Small Shell Octal 8-Pin	G-7Z	1C6
1D5-G	FIG. 10	Small Shell Octal 7-Pin	G-5Y	1A4
1E5-G	FIG. 10	Small Shell Octal 7-Pin	G-5Y	1B4
1F5-G	FIG. 11	Medium Shell Octal 7-Pin	G-6X	1F4
1F7-G	FIG. 10	Small Shell Octal 8-Pin	G-7AD	1F6
1H4-G	FIG. 9	Small Shell Octal 7-Pin	G-5S	30
1J6-G	FIG. 9	Small Shell Octal 8-Pin	G-7AB	19
5U4-G	FIG. 12	Medium Shell Octal 5-Pin	G-5T	5T4 5Z3
5Y3-G	FIG. 11	Medium Shell Octal 5-Pin	G-5T	5W4 80
6A8-G	FIG. 10	Small Shell Octal 8-Pin	G-8A	6A7 6A8
6E5	FIG. 8	Small 6-Pin	6R	-
6F6-G	FIG. 11	Medium Shell Octal 7-Pin	G-7S	6F6 42
6G5	FIG. 8	Small 6-Pin	6R	-
6J5-G	FIG. 9	Small Shell Octal 6-Pin	G-6Q (6J5-G)	6J5
6J7-G	FIG. 10	Small Shell Octal 7-Pin	G-7R (6J7-G)	6C6 6J7
6K6-G	FIG. 9	Small Shell Octal 7-Pin	G-7S	41
6K7-G	FIG. 10	Small Shell Octal 7-Pin	G-7R (6K7-G)	6D6 6K7
6L6-G	FIG. 12	Medium Shell Octal 7-Pin	G-7AC	6L6
6L7-G	FIG. 10	Small Shell Octal 7-Pin	G-7T	6L7
6N7-G	FIG. 11	Medium Shell Octal 8-Pin	G-8B	6A6 6N7
6Q7-G	FIG. 10	Small Shell Octal 7-Pin	G-7V	6Q7
6R7-G	FIG. 10	Small Shell Octal 7-Pin	G-7V	6R7
6X5-G	FIG. 9	Small Shell Octal 6-Pin	G-6S	6X5 84
25A6-G	FIG. 11	Medium Shell Octal 7-Pin	G-7S	25A6 43
25L6-G	FIG. 11	Medium Shell Octal 7-Pin	G-7AC	25L6
25Z6-G	FIG. 9	Small Shell Octal 7-Pin	G-7Q (25Z6-G)	25Z5 25Z6

# OUTLINES

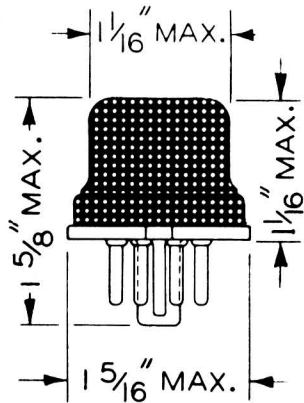

FIG. 1

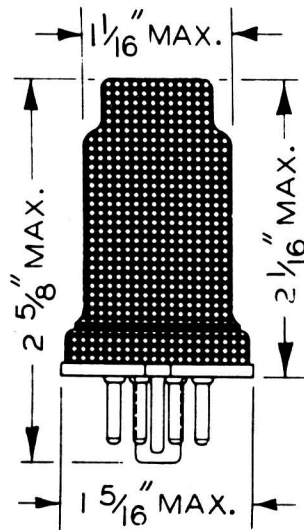

FIG. 4

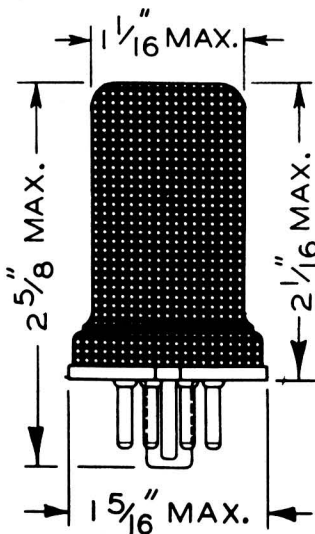

FIG. 5

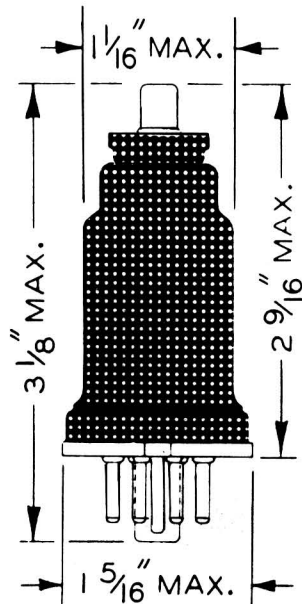

FIG. 2

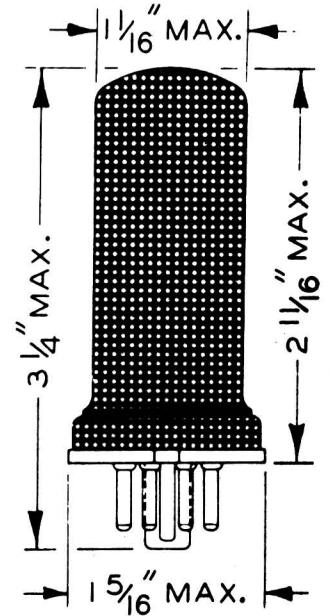

FIG. 3

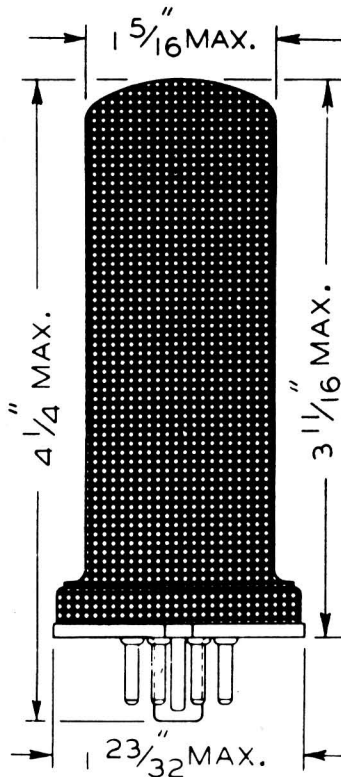

FIG. 6

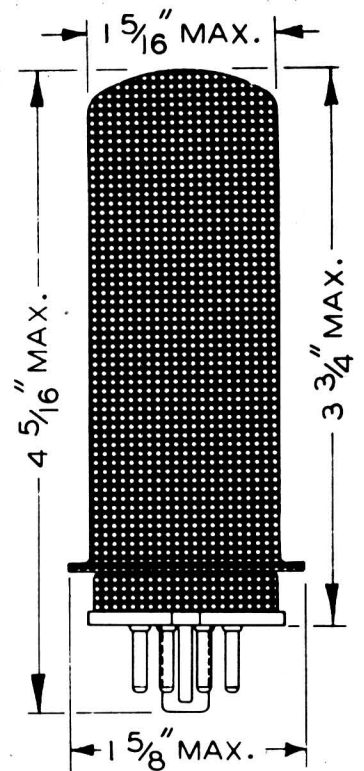

FIG. 7

# OUTLINES

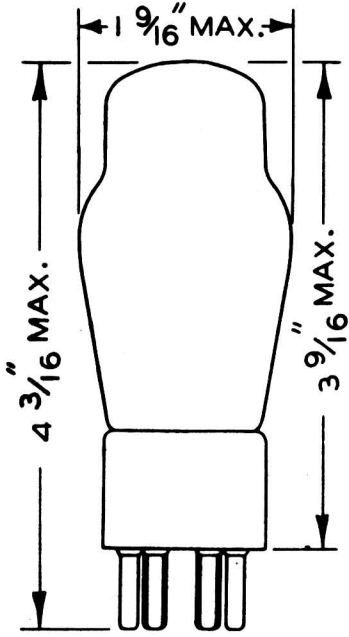

FIG. 8

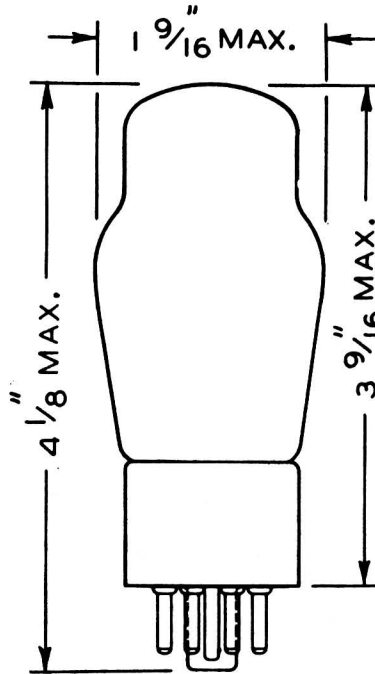

FIG. 9

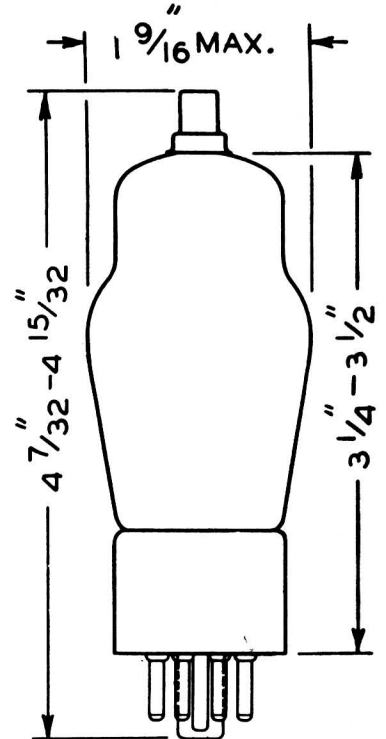

FIG. 10

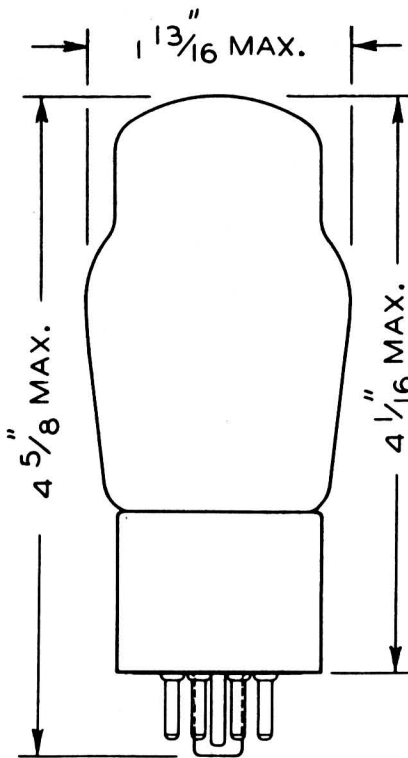

FIG. 11

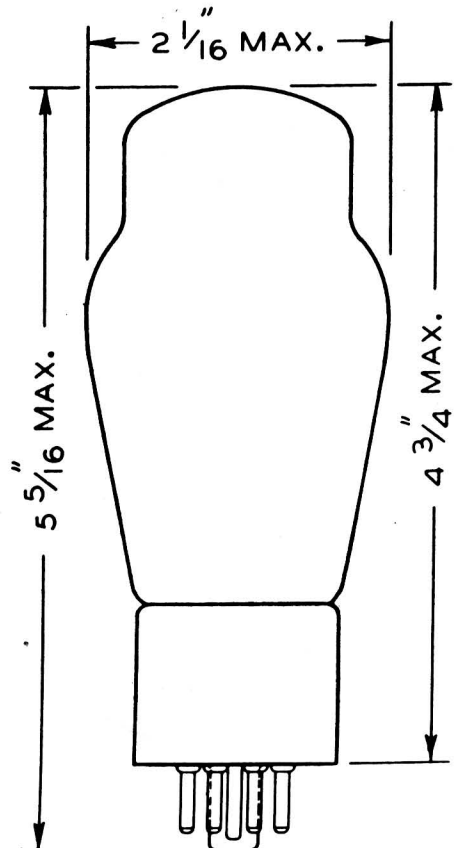
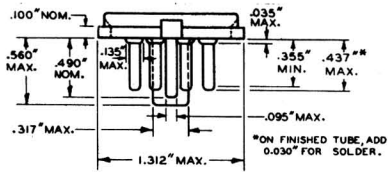

FIG. 12

# BASES AND DIMENSIONS

SMALL WAFER OCTAL 8-PIN BASE



LARGE WAFER OCTAL 8-PIN BASE

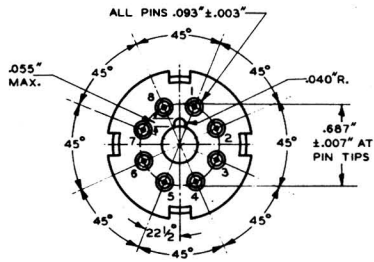
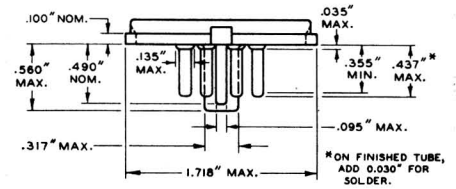

BOTTOM VIEW OF BASE

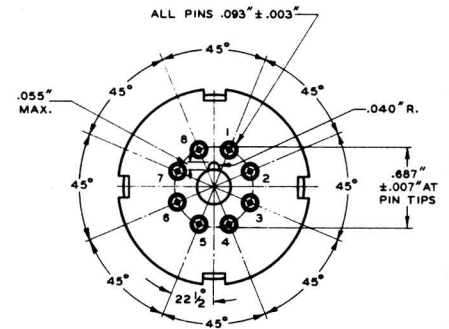

BOTTOM VIEW OF BASE

SMALL WAFER OCTAL 7-PIN BASE  
AS ABOVE, OMITTING PIN NO 6

SMALL WAFER OCTAL 6-PIN BASE  
AS ABOVE, OMITTING PINS NO 4 & 6

SMALL WAFER OCTAL 5-PIN BASES  
ARRANGEMENT A - AS ABOVE, OMITTING PINS NO 3, 5 & 6  
ARRANGEMENT B - AS ABOVE, OMITTING PINS NO 3, 5 & 7

LARGE WAFER OCTAL 5-PIN BASE  
AS ABOVE, OMITTING PINS NO 3, 5 & 7

MINIATURE CAP

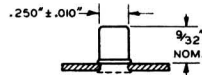

# BASES AND DIMENSIONS

SMALL SHELL OCTAL 8-PIN BASE

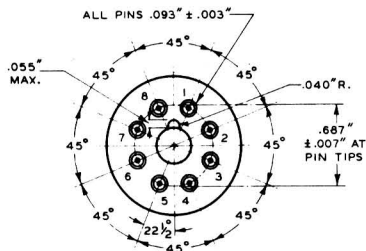
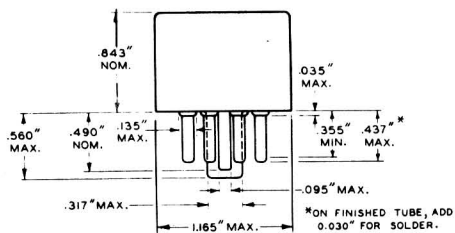

BOTTOM VIEW OF BASE

MEDIUM SHELL OCTAL 8-PIN BASE

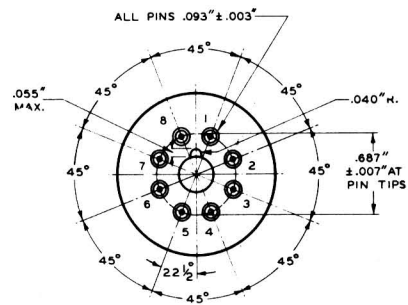
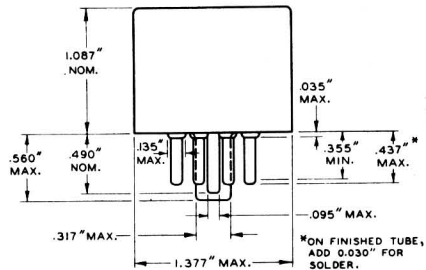

BOTTOM VIEW OF BASE

SMALL SHELL OCTAL 7-PIN BASE

AS ABOVE, OMITTING PIN N° 6

SMALL SHELL OCTAL 6-PIN BASE

AS ABOVE, OMITTING PINS N° 4 & 6

SMALL SHELL OCTAL 5-PIN BASES

ARRANGEMENT A - AS ABOVE, OMITTING PINS N° 3, 5 & 6  
ARRANGEMENT B - AS ABOVE, OMITTING PINS N° 3, 5 & 7

MEDIUM SHELL OCTAL 7-PIN BASE

AS ABOVE, OMITTING PIN N° 6

MEDIUM SHELL OCTAL 5-PIN BASE

AS ABOVE, OMITTING PINS N° 3, 5 & 6

SMALL 6-PIN BASE

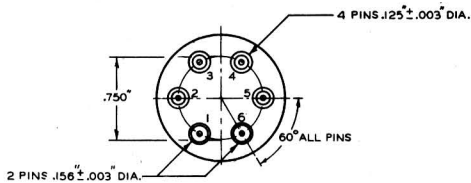
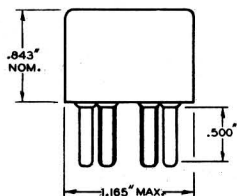

BOTTOM VIEW OF BASE

SKIRTED MINIATURE CAP

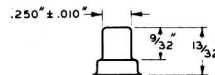



# SOCKET CONNECTIONS

## BOTTOM VIEWS

### KEY TO TERMINAL DESIGNATIONS OF SOCKETS

Alphabetical subscripts *d*, *p*, and *t* indicate, respectively, diode unit, pentode unit, and triode unit in multi-unit types.

Numerical subscripts are used (1) in multi-grid types to indicate relative position of grids to cathode or filament, and (2) in multi-unit types to differentiate between two identical electrodes which would otherwise have the same designation.

**F** = Filament  
**G** = Grid  
**H** = Heater

**K** = Cathode  
**NC** = No Connection  
**P** = Plate

**P<sub>BF</sub>** = Beam-Forming Plates  
**S** = Shell  
**TA** = Target

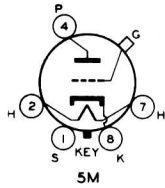

5M

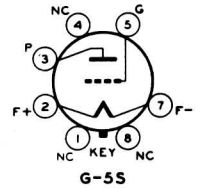

G-5S

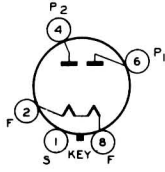

5T

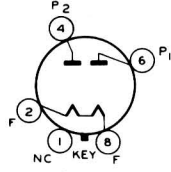

G-5T

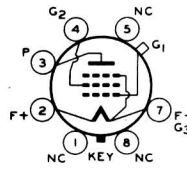

G-5Y

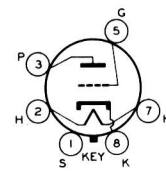

6Q

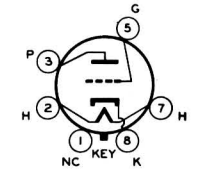

G-6Q (6J5-G)

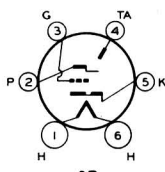

6R

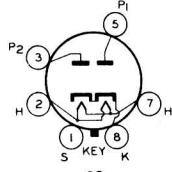

6S

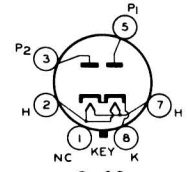

G-6S

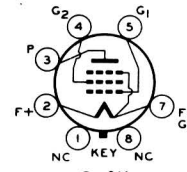

G-6X

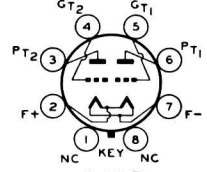

G-7AB

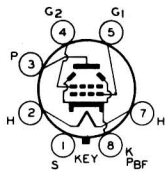

7AC

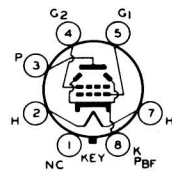

G-7AC

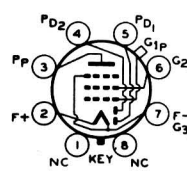

G-7AD

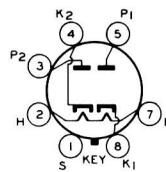

7Q

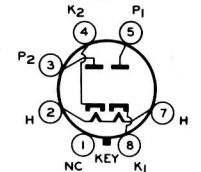

G-7Q (2526-G)

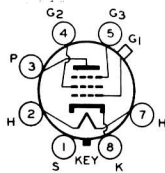

7R

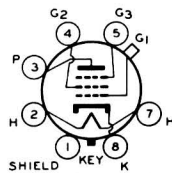

G-7R (6J7-G)

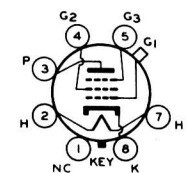

G-7R (6K7-G)

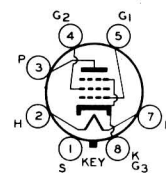

7S

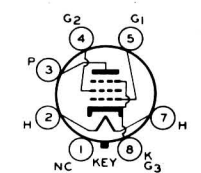

G-7S

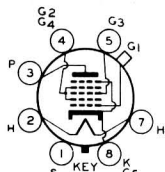

7T

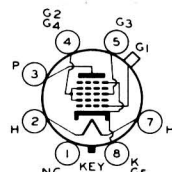

G-7T

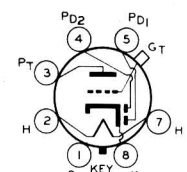

7V

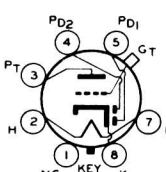

G-7V

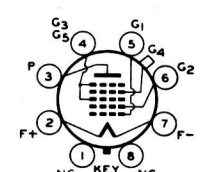

G-7Z

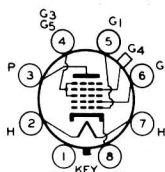

8A

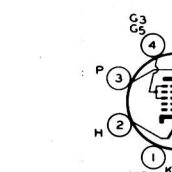

G-8A



8B

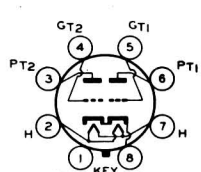

G-8B